

Ma

KEY STAGE

3

TIER

4–6

Mathematics test

Paper 1

Calculator not allowed

First name _____

Last name _____

School _____

Remember

- The test is 1 hour long.
- You **must not** use a calculator for any question in this test.
- You will need: pen, pencil, rubber, ruler, tracing paper and mirror (optional).
- Some formulae you might need are on page 2.
- This test starts with easier questions.
- Try to answer all the questions.
- Write all your answers and working on the test paper – do not use any rough paper. Marks may be awarded for working.
- Check your work carefully.
- Ask your teacher if you are not sure what to do.

For marker's use only

TOTAL MARKS	
-------------	--

2008

Instructions

Answers



This means write down your answer or show your working and write down your answer.

Calculators



You **must not** use a calculator to answer any question in this test.

Formulae

You might need to use these formulae

Trapezium

$$\text{Area} = \frac{1}{2}(a + b)h$$

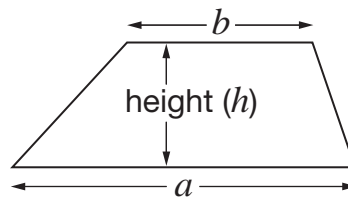

Prism

area of cross-section

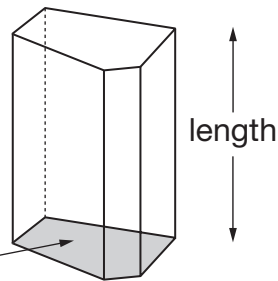

$$\text{Volume} = \text{area of cross-section} \times \text{length}$$

1. Work out the following.

$$65 \times 9$$



1 mark

$$154 \div 7$$



1 mark



2. Here is a number line.

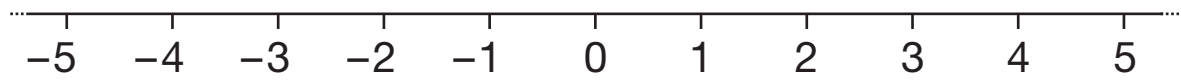

It can help you work out the answers to the calculations below.

The first one is done for you.

$$-3 + 1 = \underline{-2}$$



$$-4 + 1 = \underline{\hspace{2cm}}$$

1 mark



$$-2 + 5 = \underline{\hspace{2cm}}$$

1 mark



$$3 - 5 = \underline{\hspace{2cm}}$$

1 mark

3. 8 people took part in a chess competition.

The diagram shows how many games each person won, and how many games each person lost.

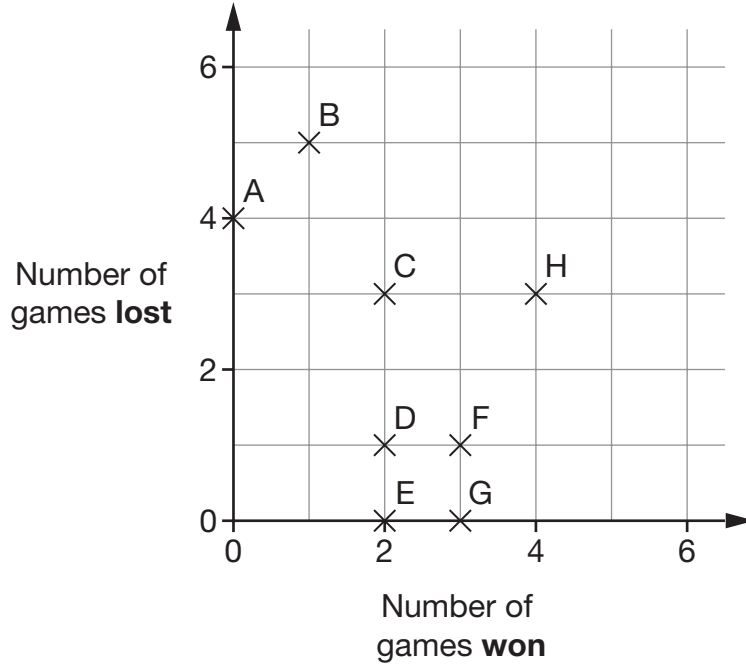

(a) Who won the most games? Write the person's letter.



1 mark

(b) How many games were won by person **A**?



1 mark

(c) Each person played **7 games**.

Each game was won, lost or drawn.

How many of person **D**'s games were **drawn**?



1 mark



4. Write the missing numbers in the boxes.

 $8 \times \square = 800$

1 mark

 $0.8 \times \square = 8$

1 mark

5. Look at the calculation below.

Write the correct digits in the boxes.

 $\begin{array}{|c|c|c|} \hline 4 & 3 & \square \\ \hline \end{array} + \begin{array}{|c|c|c|} \hline 2 & \square & 8 \\ \hline \end{array} = \begin{array}{|c|c|c|} \hline \square & 7 & 5 \\ \hline \end{array}$

2 marks

6. On the square grid below, some squares are shaded to make a pattern with exactly **4 lines** of symmetry.

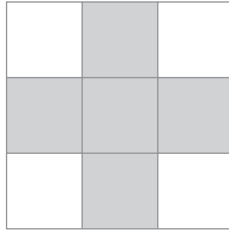

- (a) On the square grid below, shade some squares to make a pattern with exactly **2 lines** of symmetry.

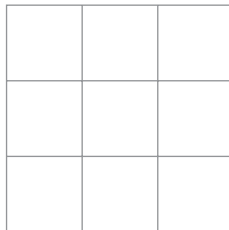

 1 mark

- (b) On the square grid below, shade some squares to make a pattern with exactly **1 line** of symmetry.

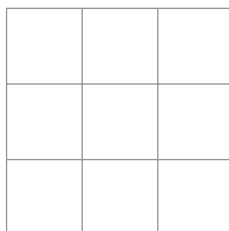

 1 mark

7. (a) Henry thinks of a number **between 1 and 20**

He thinks of the number **12**

For each question below, tick (✓) Yes or No for Henry's number.

	Yes	No
 Is it an even number?		
Is it a multiple of 3 ?		
Is it a factor of 18 ?		

1 mark

(b) Ashraf also thinks of a number **between 1 and 20**

The table shows information about his number.

	Yes	No
Is it an even number?		✓
Is it a multiple of 3 ?	✓	
Is it a factor of 18 ?		✓

What is Ashraf's number?



1 mark

8. Look at the dial.

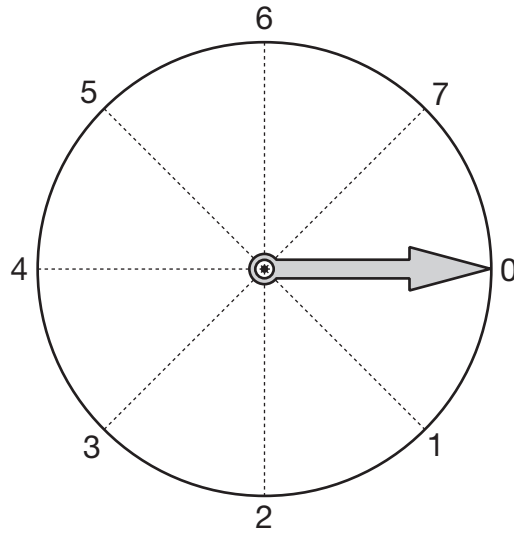

The pointer starts at 0 and turns **clockwise** around the centre.

- (a) Which number does it point to after turning clockwise through **90°** ?



1 mark

- (b) The pointer turns clockwise from **3 to 6**
Through how many degrees does it turn?



1 mark



9. The table shows the temperatures in 10 cities on a day in December.

City	Temperature in °C
Athens	18
Barcelona	16
Berlin	7
Brussels	8
Dublin	9
Geneva	6
Madrid	12
Moscow	2
Paris	6
Rome	19

- (a) Which temperature was the **mode**?



_____ °C

_____ 1 mark

- (b) In a different city, the temperature was **5°C lower** than in **Moscow**.

What was the temperature in this city?



_____ °C

_____ 1 mark

10. Write two numbers that add to 10

One of the numbers must be **positive**.

The other number must be **negative**.

 + =

1 mark

11. Work out the following.

$$1.2 \times 6$$



1 mark

$$1.2 \div 6$$



1 mark



(a) How many leaves were in each container on day **1**?



_____ 1 mark

(b) In container **A**, how many **more** leaves were there on day **19** than on day **1**?



_____ 1 mark

(c) Duckweed plants with no leaves are dead.

On which day did the pupils record that the plants in container **B** were dead?



Day _____

_____ 1 mark

(d) How did the amount of salt affect the **change** in the number of leaves?



_____ 1 mark



13. Each shape in this question is made from **six cubes**.

Look at this shape.

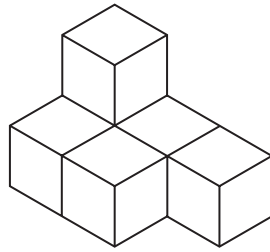

Which **two** of the diagrams below show the **same** shape?

Tick (✓) them both.

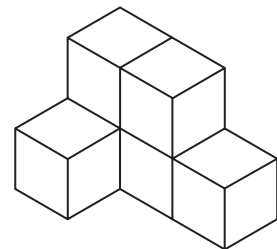
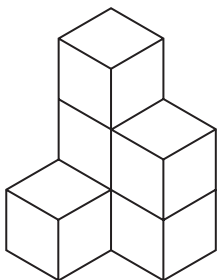
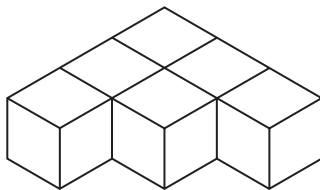
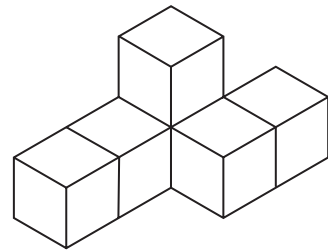
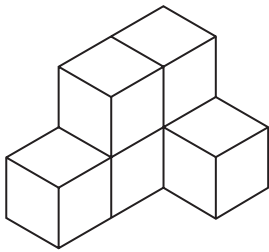

1 mark

14. Write **numbers** in the boxes to make the statements true.



When $x =$ then $x + 3 =$

When $x =$ then $3x =$

When $x =$ then $\frac{x}{3} =$

2 marks

15. Boxes of tins are delivered to a shop.

There are **37 boxes**.

Each box contains **25 tins**.

How many tins are there?



2 marks



16. (a) Write the correct numbers in the gaps below.

$$1 \times 3\frac{1}{2} = 3\frac{1}{2}$$

$$2 \times 3\frac{1}{2} = 7$$

$$3 \times 3\frac{1}{2} = 10\frac{1}{2}$$



$$4 \times 3\frac{1}{2} = \underline{\hspace{2cm}}$$

1 mark



$$5 \times 3\frac{1}{2} = \underline{\hspace{2cm}}$$

1 mark

$$6 \times 3\frac{1}{2} = 21$$

Use the table to help you work out this calculation.



$$60 \times 3\frac{1}{2} = \underline{\hspace{2cm}}$$

1 mark

(b) Is the answer to $11 \times 3\frac{1}{2}$ a whole number?



Yes

No

Explain your answer.



1 mark

17. Find the values of x

$$5x - 3 = 12$$



$x = \underline{\hspace{2cm}}$

1 mark

$$13 + 2x = 3$$



$x = \underline{\hspace{2cm}}$

1 mark

18. Look at the square drawn on the graph.

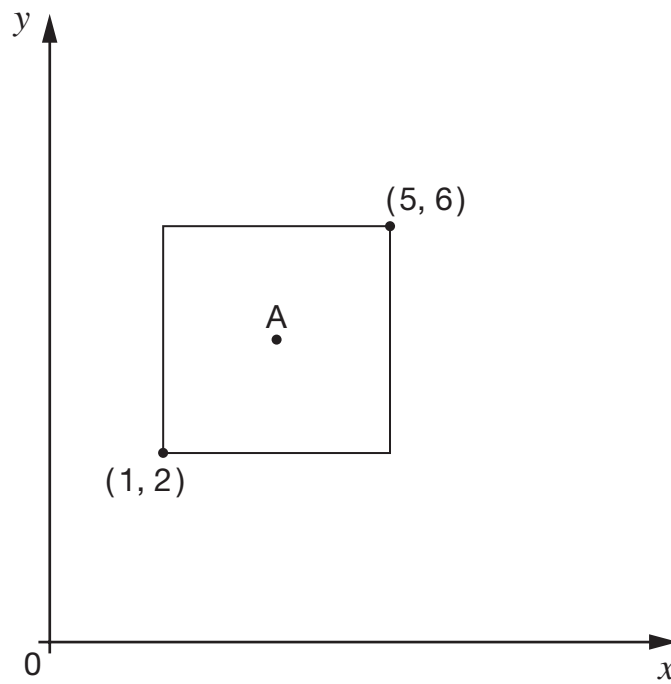

Not drawn
accurately

Point A is the centre of the square.

What are the coordinates of point A?



A is (_____ , _____)

2 marks

19. Match each expression on the left with the equivalent expression on the right.

The first one is done for you.



$3d + d$		3
$3d - d$		$2d$
$3d \times d$		$3d$
$3d \div d$		$4d$
		$2d^2$
		$3d^2$
		$2d^3$

2 marks



20. Look at the two triangular prisms.

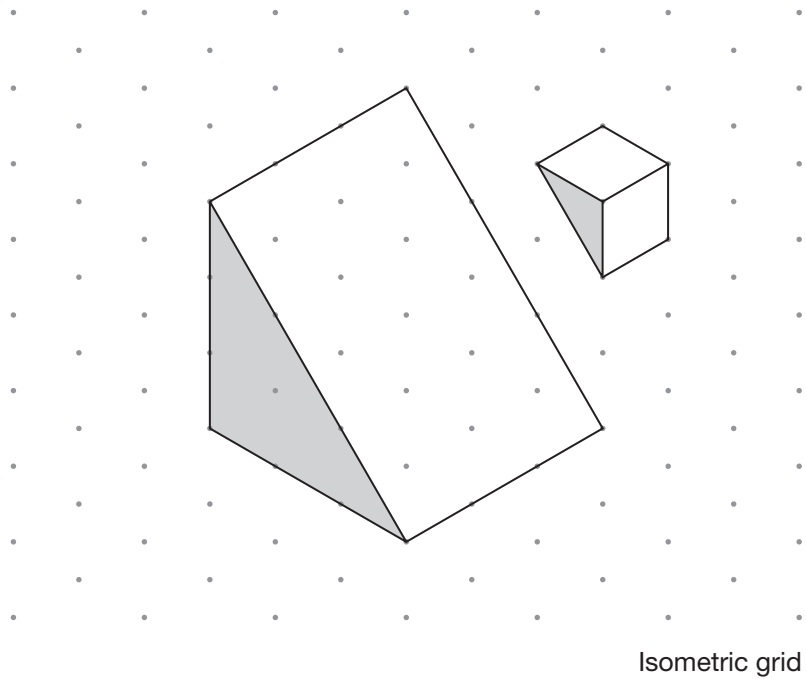

They are joined to make the new shape below.

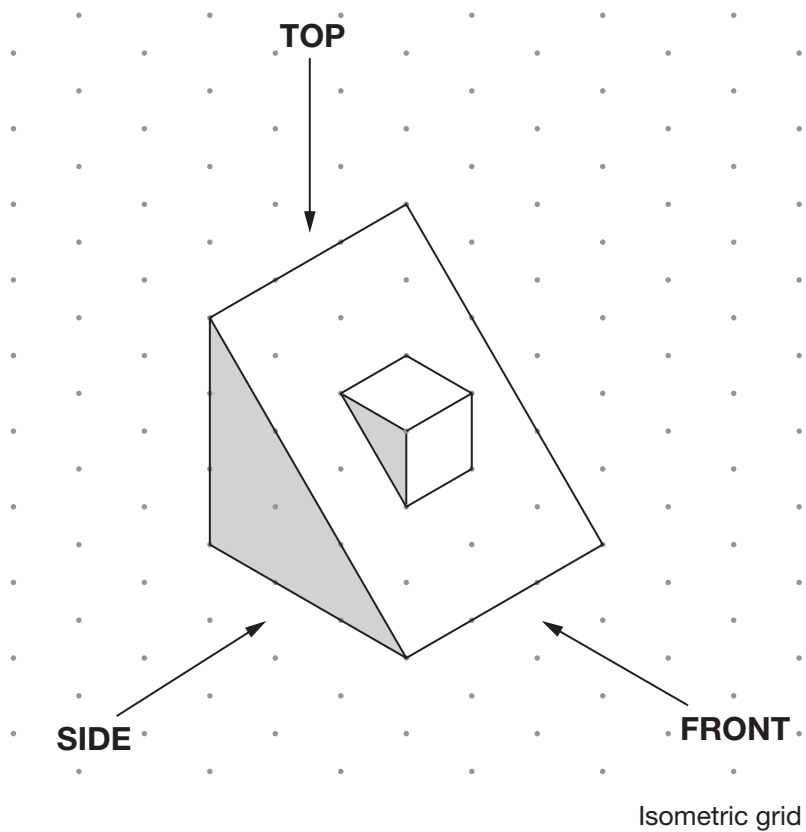

Complete the views of the new shape on the grid.

The first one is done for you.

View from the **TOP** View from the **FRONT** View from the **SIDE**

Square grid

2 marks

21. I am thinking of a number.

My number is a **multiple of 6**

What **three other numbers** must my number be a multiple of?

_____, _____ and _____

1 mark



22. There are **25 pupils** in a class.

The table shows information about their test results in maths and English.

		English		
		Level 5	Level 6	Level 7
maths	Level 5	0	1	1
	Level 6	2	7	0
	Level 7	2	1	4
	Level 8	0	1	6

(a) How many pupils had the **same level** in both maths and English?



1 mark

(b) How many pupils had a **higher level** in **maths** than in English?



1 mark

23. The diagram shows a square with a **perimeter** of **12cm**.



Not drawn
accurately

Six of these squares fit together to make a rectangle.



Not drawn
accurately

What is the **area** of the **rectangle**?

You **must** give the correct unit with your answer.

1 mark



1 mark



24. The table shows whether pupils in a class walk to school.

	Walk to school	Do not walk to school
Boys	2	8
Girls	5	10

(a) What percentage of the **boys** walk to school?



_____ %

_____ 1 mark

(b) What percentage of the **pupils** in this class walk to school?



_____ %

_____ 2 marks

25. A pupil recorded the times of **23** people running the 100 metres.
The stem-and-leaf diagram shows the results.

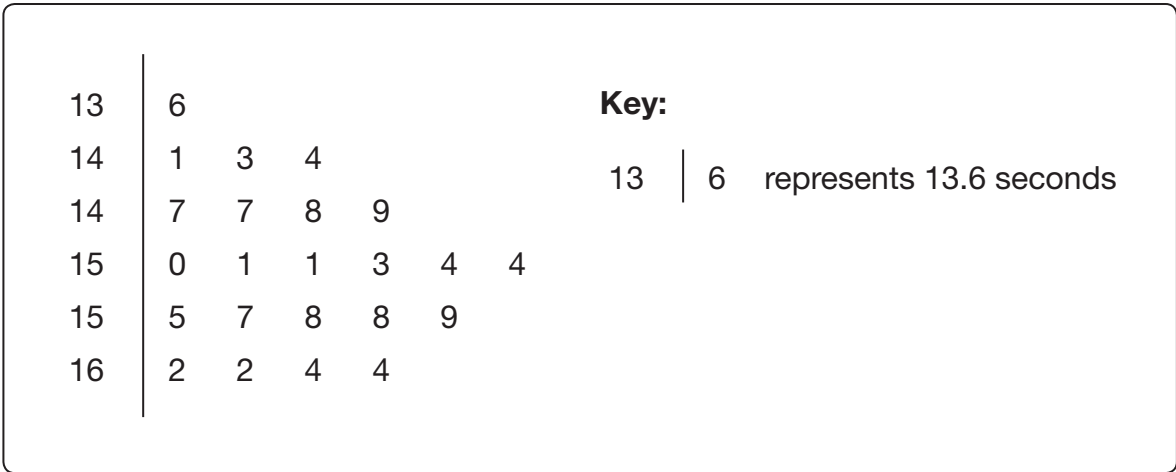

(a) Two of the people ran the 100 metres in **14.7 seconds**.

How many of them ran the 100 metres **faster** than this?



_____ people

1 mark

(b) What was the **range** of times?



seconds

2 marks



26. For each sequence below, tick (✓) the correct box to show if it is **increasing**, **decreasing** or **neither**.



				increasing	decreasing	neither
$\frac{1}{2}$	$\frac{1}{3}$	$\frac{1}{4}$	$\frac{1}{5}$	<input type="checkbox"/>	<input type="checkbox"/>	<input type="checkbox"/>
$\frac{6}{13}$	$\frac{7}{12}$	$\frac{8}{11}$	$\frac{9}{10}$	<input type="checkbox"/>	<input type="checkbox"/>	<input type="checkbox"/>
$\frac{1}{2}$	$\frac{2}{4}$	$\frac{3}{6}$	$\frac{4}{8}$	<input type="checkbox"/>	<input type="checkbox"/>	<input type="checkbox"/>
$\frac{3}{2}$	$\frac{4}{3}$	$\frac{5}{4}$	$\frac{6}{5}$	<input type="checkbox"/>	<input type="checkbox"/>	<input type="checkbox"/>

2 marks

27. Find the value of x

$$6 + 2x = x - 6$$



$$x = \underline{\hspace{2cm}}$$

2 marks

28. Work out



$$\frac{1 \times 2 \times 3 \times 4 \times 5}{1 \times 2 \times 3} = \underline{\hspace{2cm}}$$

1 mark



END OF TEST