

Ma

KEY STAGE

3

TIER

3–5**2003**

Mathematics test

Paper 2

Calculator allowed

Please read this page, but do not open your booklet until your teacher tells you to start. Write your name and the name of your school in the spaces below.

First name _____

Last name _____

School _____

Remember

- The test is 1 hour long.
- You may use a calculator for any question in this test.
- You will need: pen, pencil, rubber, ruler and a calculator.
- This test starts with easier questions.
- Try to answer all the questions.
- Write all your answers and working on the test paper – do not use any rough paper. Marks may be awarded for working.
- Check your work carefully.
- Ask your teacher if you are not sure what to do.

For marker's
use only

Total marks	
Borderline check	

Instructions

Answers



This means write down your answer or show your working and write down your answer.

Calculators



You **may** use a calculator to answer any question in this test.

1. (a) Look at these shapes.

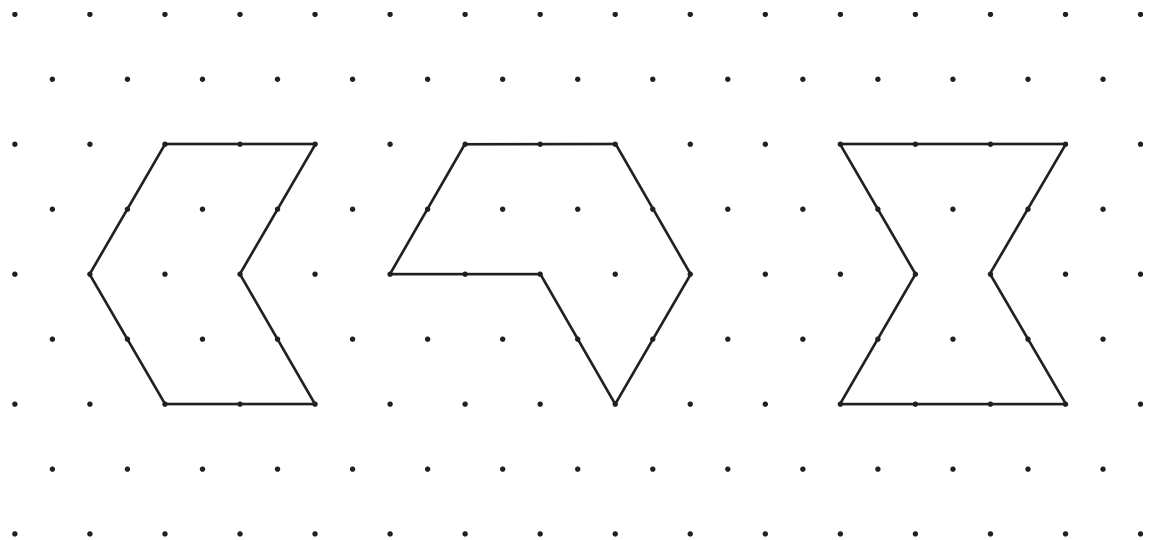

Isometric grid

Explain why the shapes are **hexagons**.



1 mark

(b) Draw a **regular hexagon** on the grid below.

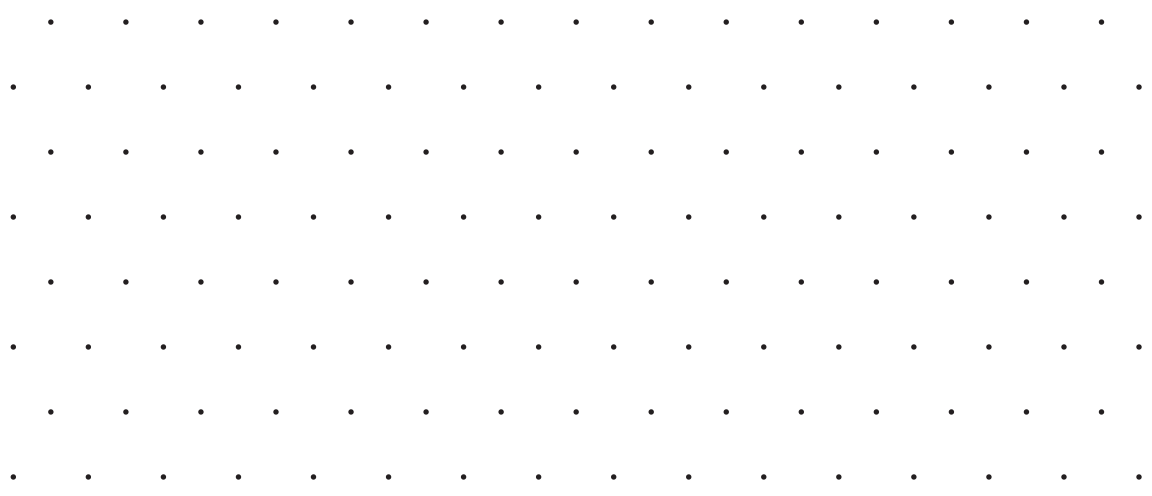

Isometric grid 1 mark



2. Look at this diagram.
It shows distances in miles between some cities.

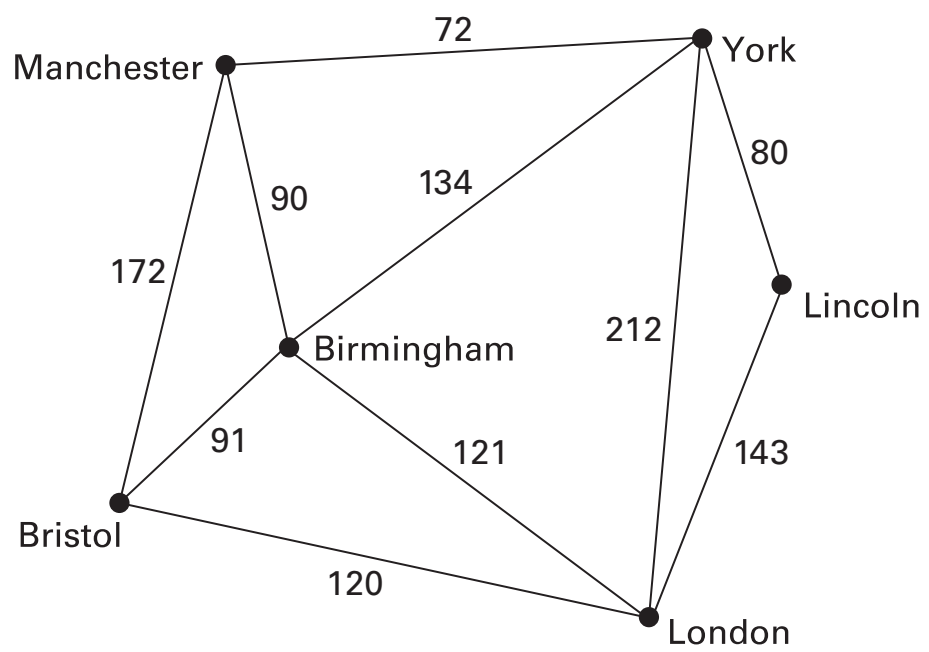

Not drawn accurately

(a) How far is it from **Bristol** to **Manchester**?

 miles

.....
1 mark

(b) Which two cities are **212 miles** apart?

 and

.....
1 mark

(c) Kim lives in Birmingham.
She wants to visit either **York** or **London**.

Which of these cities is **nearer to Birmingham**?

Tick (✓) your answer.



York

London

How many miles nearer to Birmingham is it?



..... miles

.....
1 mark

(d) Sanjay drives from **London to Bristol**,
then he drives **to Birmingham**,
and then he drives directly back **to London**.

How many miles does he drive altogether?

Show your working.



..... miles

.....
.....
2 marks

3. (a) Look at these three number cards.

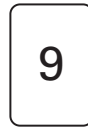

You can put them together to show different numbers.

For example:



ninety-four

Put the three cards together in a different way.

Write **in words** what number the cards show.

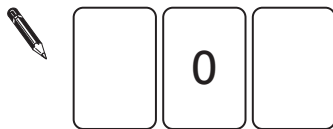

.....

.....
1 mark

Now put the three cards together in another different way.

Write **in words** what number the cards show.



.....

.....
1 mark

(b) Here are three different number cards.

5

8

3

What is the **biggest** number you can show with these cards?



1 mark

What is the **biggest even** number you can show with these cards?



1 mark



4. A school records how many pupils are late each day.
The bar charts show the results for one week.

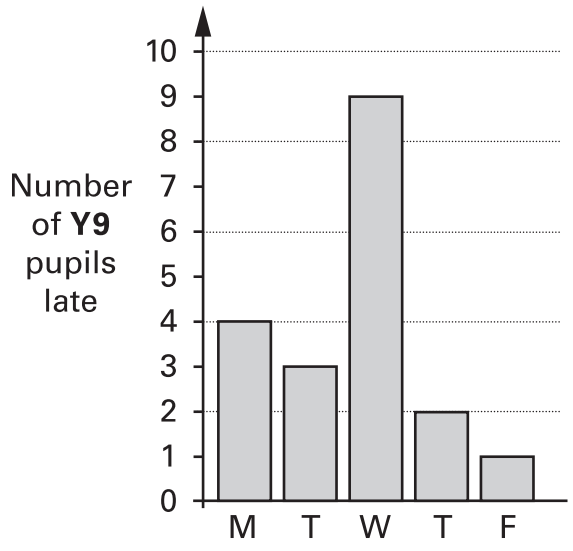
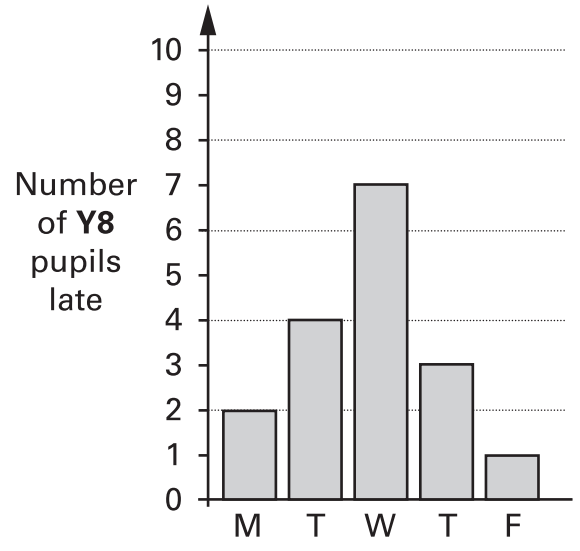
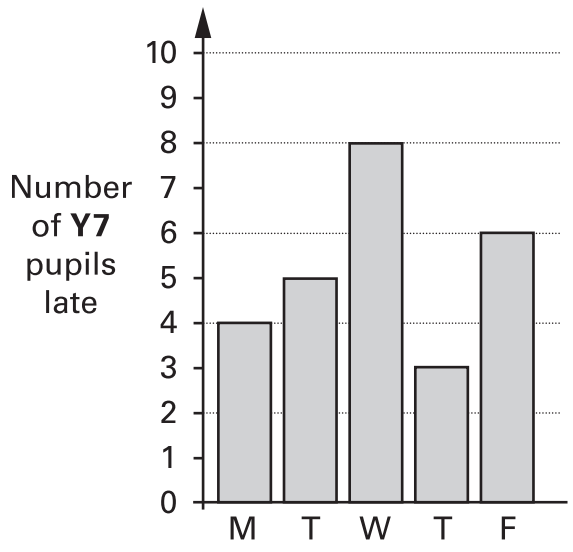

(a) **Altogether**, how many pupils were late on **Monday**?



.....

.....
1 mark

(b) **Altogether**, how many lates were recorded for **Y9** pupils?



.....

.....
1 mark

(c) The school bus broke down on one of the days.

Which day do you think that was?



.....

Explain why you chose that day.



.....
1 mark



5. (a) I slice a cube in half like this:

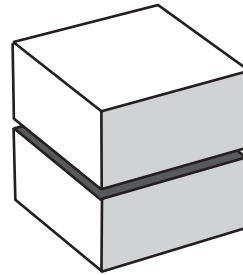

How many faces does each piece have?



.....

.....
1 mark

(b) Then I slice another cube in half like this:

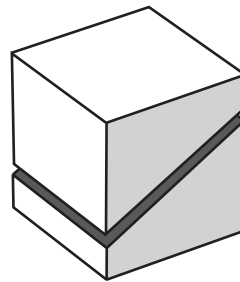

How many faces does each piece have?



.....

.....
1 mark

(c) I slice a different cube in half through its corners like this:

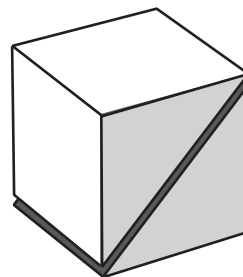

How many faces does each piece have?



.....

.....
1 mark

6. Alice and Ben each buy a bicycle but they pay in different ways.

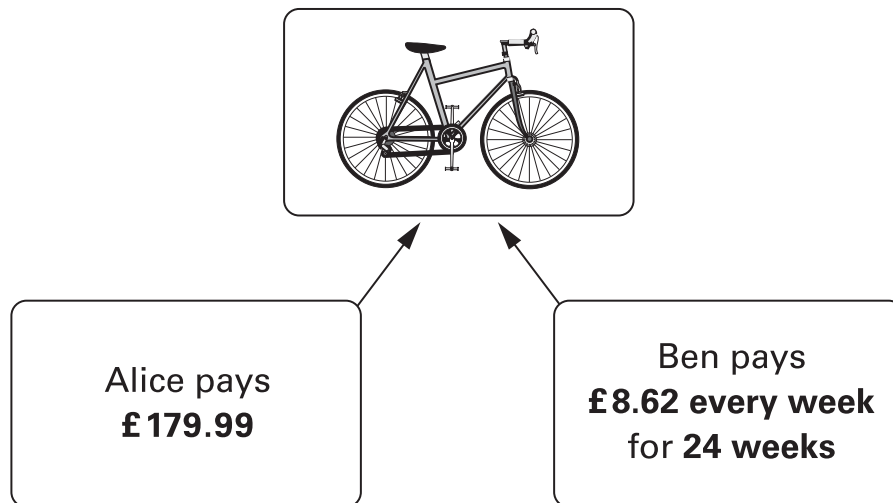

Ben pays more than Alice.

How much more?

Show your working.



£

.....
.....
2 marks



7. Mark did a survey.

He asked pupils in his school:

‘Do you like the colour of the school uniform?’

The table shows his results.

	Yes	No	Don't know
Year 7	35	17	2
Year 8	20	24	5
Year 9	19	17	6

(a) How many pupils from **year 7** took part in the survey?



.....

.....
1 mark

(b) Altogether, more pupils said ‘**Yes**’ than said ‘**No**’.

How many more?



.....

.....
1 mark

- (c) Mark asked the same question to **40 pupils in year 11**
25% said 'Yes'. **50%** said 'No'. The rest said 'Don't know'.

Complete the table to show how many pupils from year 11 gave each answer.

	Yes	No	Don't know
 Year 11			

.....

 2 marks





- (d) Anna does a different survey with pupils in year 9
 She wants to know if more boys than girls have pets.

She asks:

'Do you have a pet?'

What labels should Anna use on her results table?

Fill in the missing labels.

.....
 1 mark



8. The chart shows information about seven kings and queens.
It shows their ages when they died and how many years they ruled.

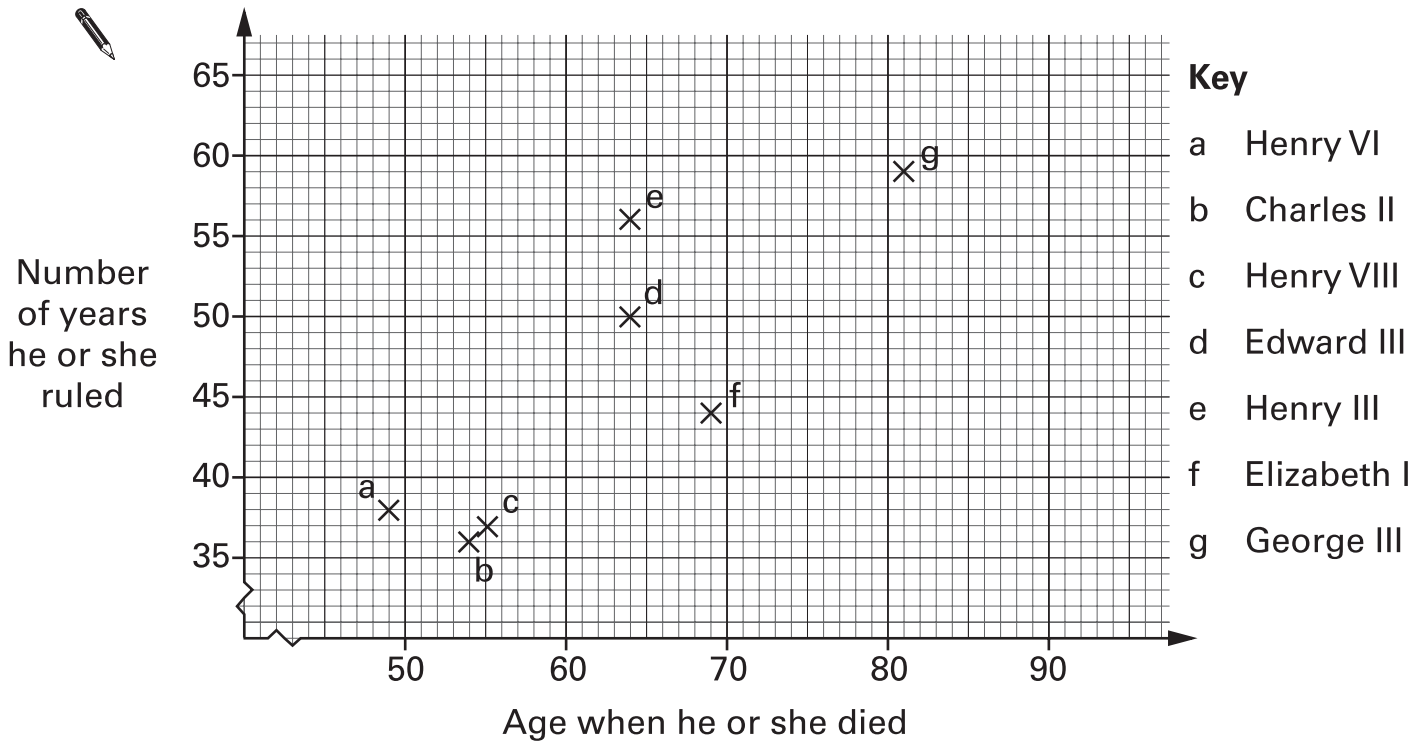

Use the chart to answer these questions.

- (a) For how many years did **Edward III** rule?



..... years

.....
1 mark

- (b) Which king or queen died at the age of 69 and ruled for 44 years?



.....

.....
1 mark

- (c) Queen Victoria died at the age of 81 and ruled for 63 years.

Put a cross on the chart to show this information.

.....
1 mark

9. The table shows how much it costs to go to a cinema.

	Before 6pm	After 6pm
Adult	£ 3.20	£ 4.90
Child (14 or under)	£ 2.50	£ 3.50
Senior Citizen (60 or over)	£ 2.95	£ 4.90

Mrs Jones (aged 35), her daughter (aged 12), her son (aged 10) and a friend (aged 65) want to go to the cinema.

They are not sure whether to go before 6pm or after 6pm.

How much will they save if they go **before** 6pm?

Show your working.



£

.....

 3 marks



10. (a) The thermometer shows Alan's temperature.

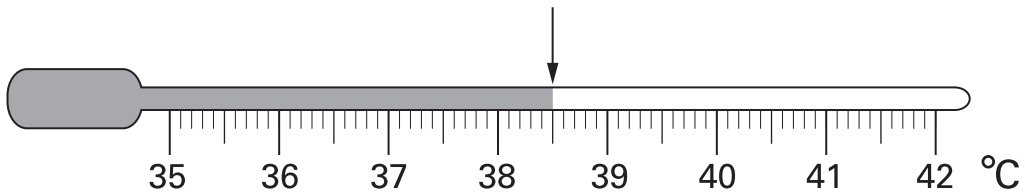

Alan's normal temperature is **37.0°C**

How many degrees **higher than normal** is Alan's temperature?

 °C

1 mark

(b) On Monday morning, Bina's temperature was **39.2°C**

By Tuesday morning, Bina's temperature had **fallen** by **1.3°C**

What was Bina's temperature on Tuesday morning?

 °C

1 mark

(c) You can measure temperature in $^{\circ}\text{C}$ or in $^{\circ}\text{F}$

The diagram shows how to change $^{\circ}\text{F}$ to $^{\circ}\text{C}$

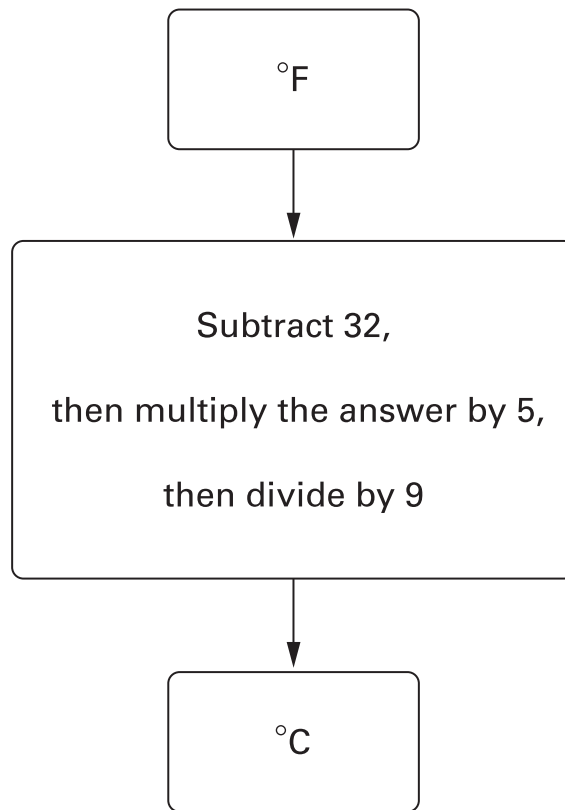

The highest temperature ever recorded in a human was **115.7 $^{\circ}\text{F}$**

What is this temperature in **$^{\circ}\text{C}$** ?

Show your working.



.....
.....
2 marks



11. In this question, all the grids are centimetre square grids.

(a) Draw a **rectangle** that has an **area of 12cm^2**

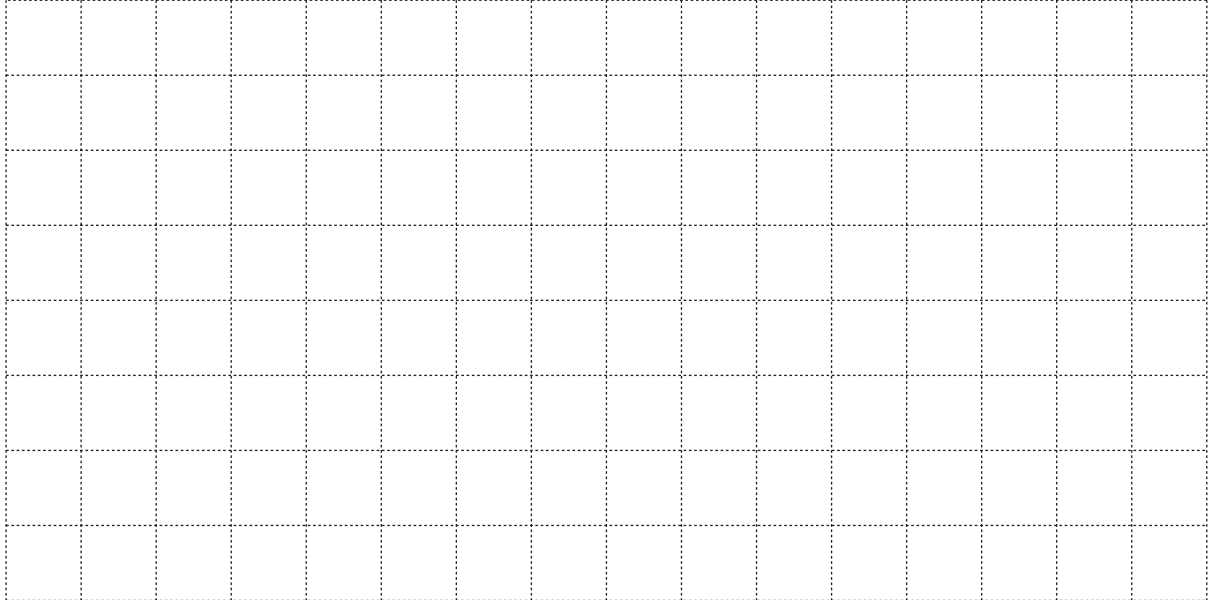

1 mark

(b) Draw another rectangle that has an area of 12cm^2

This rectangle must have a **different perimeter** from the rectangle in part (a).

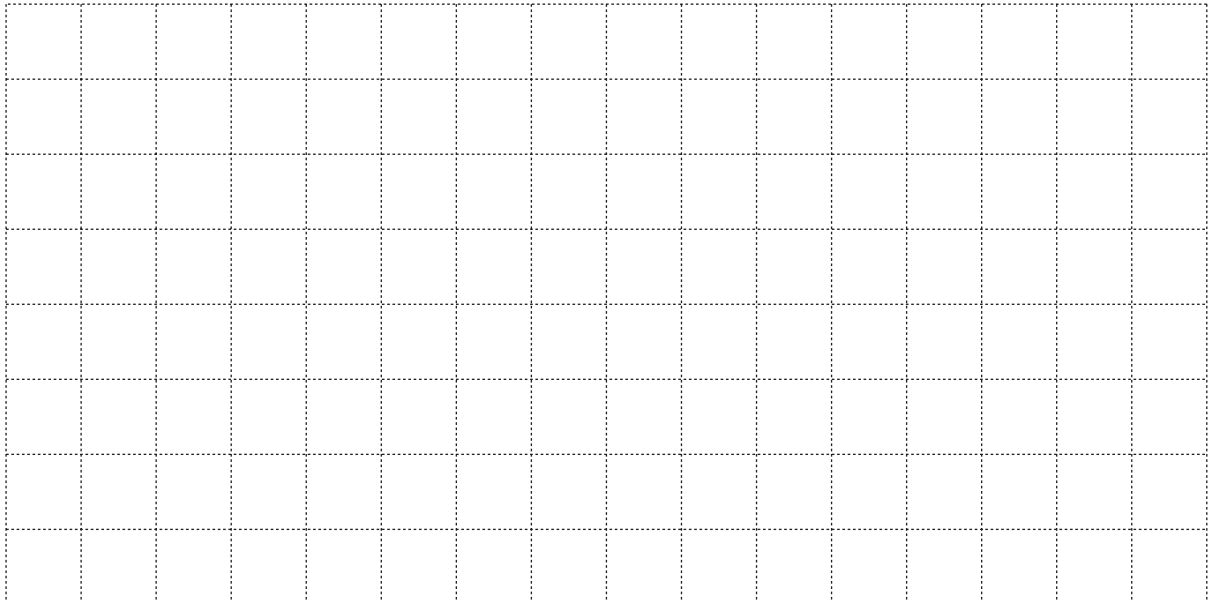

1 mark

(c) Draw a **triangle** that has an **area of 6cm^2**

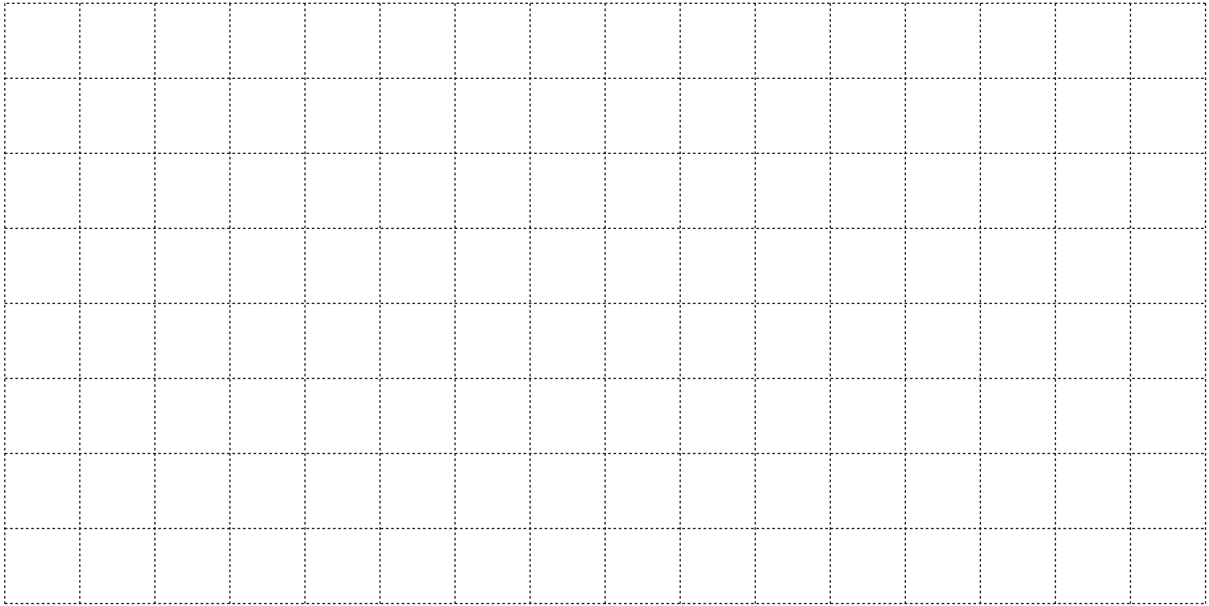

1 mark



12. I have two bags of cubes.
 Each bag contains more than 20 but fewer than 30 cubes.

(a) I can **share** the cubes in bag A
equally between 9 people.

How many cubes are in bag A?

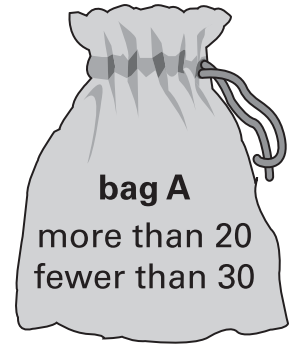





.....
 1 mark

(b) I can **share** the cubes in bag B
equally between 4 people.

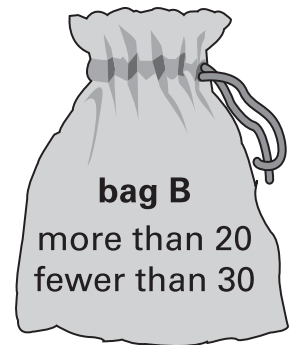
How many cubes could be in bag B?
 There are two answers. Write them both.



 or

.....

 2 marks

13. Each diagram below was drawn on a square grid.

(a) Write what **percentage** of each diagram is shaded.

The first one is done for you.

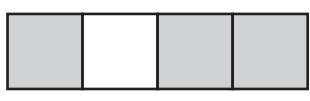

..... 75 %

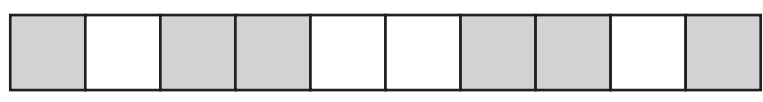

..... %

.....
1 mark

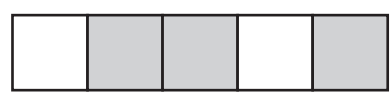

..... %

.....
1 mark

(b) Explain how you know that $12\frac{1}{2}\%$ of the diagram below is shaded.



.....
1 mark

(c) Shade $37\frac{1}{2}\%$ of the diagram below.



.....
1 mark



14. (a) It is Tina's birthday. We do not know how old Tina is.

Call **Tina's age**, in years, n

The expressions below compare Tina's age to some other people's ages.

Use words to compare their ages. The first one is done for you.

Tina's age	n
Ann's age	$n + 3$

Ann is *3 years older than Tina*

Tina's age	n
Barry's age	$n - 1$



Barry is

Tina's age	n
Carol's age	$2n$



Carol is

.....
.....
2 marks

(b) In one year's time Tina's age will be $n + 1$

Write **simplified expressions** to show the ages of the other people in one year's time.

	Tina	Ann	Barry	Carol
Age now	n	$n + 3$	$n - 1$	$2n$
Age in one year's time	$n + 1$



.....
.....
2 marks

(c) When $n = 30$, find the value of $2n + 1$



.....

.....
1 mark

When $n = 30$, find the value of $2(n + 1)$



.....

.....
1 mark



15. Some pupils plan a survey to find the most common types of tree in a wood.

Design 1

Instructions:

Write down the type of each tree that you see.

For example:

Elm, oak, oak,
oak, sycamore, ash, ...

Design 2

Instructions:

Use these codes to record the type of each tree that you see.

Ash A
Birch B
Elm E
Oak O
Sycamore S

For example:

E, O, O, O, S, A, ...

Design 3

Instructions:

Use a tally chart to record the type of each tree that you see.

For example:

Type of tree	Tally
Ash	I
Birch	
Elm	I
Oak	III
Sycamore	I
Other	

The pupils will only use one design.

(a) Choose a design they should **not** use.



Design

Explain why it is not a good design to use.



.....
1 mark

(b) Choose the design that is the best.



Design

Explain why it is the best.



.....
1 mark

16. (a) Jo has these **4 coins**.



Jo is going to take one of these coins at random.

Each coin is equally likely to be the one she takes.

Show that the **probability** that it will be a **10p** coin is $\frac{1}{2}$



.....
1 mark

(b) Colin has **4 coins** that total **33p**.

He is going to take one of his coins at random.

What is the probability that it will be a **10p** coin?

You **must** show your working.



.....
1 mark



17. Look at the diagram.
 Triangle ABD is the reflection of triangle ABC in the line AB.

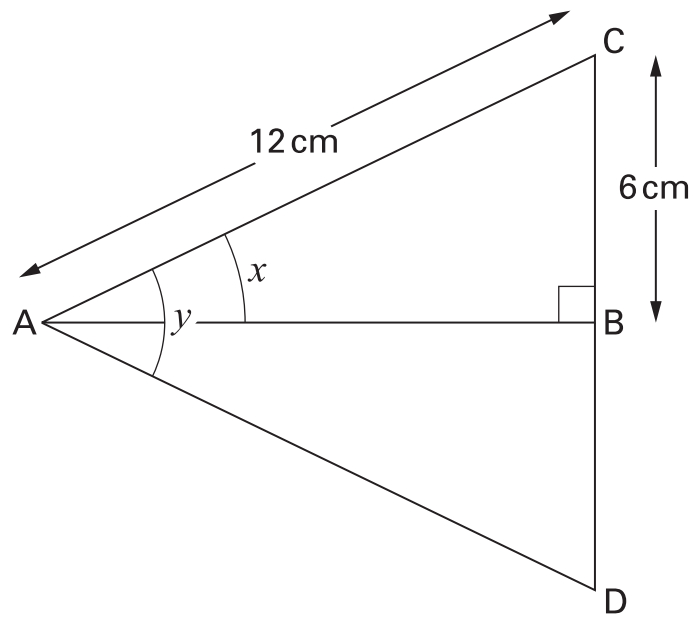

Not drawn accurately

Fill in the gaps below to explain how to find angle x

The length of AC is ¹² cm.

 The length of AD is cm.

The length of CD is cm.

ACD is an equilateral triangle because 1 mark

so angle y is^o because 1 mark

so angle x is^o because 1 mark

18. (a) A glass holds **225 ml**.

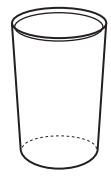

225 ml

An adult needs about **1.8 litres** of water each day to stay healthy.

How many glasses is that?

Show your working.



.....

.....

.....
2 marks

(b) An adult weighs **80 kg**.
60% of his total mass is water.

What is the mass of this water?



..... kg

.....
1 mark



END OF TEST